

## Technical data sheet

Load monitoring · LOCC-Box-EC

---

**Electronic circuit breaker rated up to DC 10 A**

**Single channel version, fixed current range: DC 3 A**

**Fixed characteristic: slow 1**



---

### Identification

Type	LOCC-BOX-EC I3-C3
Part No.	<a href="#">716407.3300</a>

---

### Product version

Hardware revision	2.0
Software version	<b>2.6</b>
Datasheet version	02

---

### Input

Type of function	1-channel 1 pin switching
Rated voltage $U_N$	DC 12/24 V
Operation voltage range	DC 10–30 V
Rated current $I_N$	DC 10 A
Supply current	DC 40 A over Cu-rails 10 × 3 mm
Reverse voltage protection	Internal electronics
Connection type input	Screwless contact slide

---

### Control input (Set / Reset)

Signal level	DC 12/24 V acc. to IEC 61131-2
--------------	--------------------------------

---

### Output

Switching element	MOSFET
Output current	Max. DC 10 A
Voltage drop	Max. 215 mV (10 A)

---

#### United Kingdom: LÜTZE Ltd.

Unit 3, Sandy Hill Park  
Sandy Way, Amington • GB-Tamworth, Staffs B77 4DU  
Tel. +44 (0)1827 31333-0  
[www.lutze.com](http://www.lutze.com) • [sales.gb@lutze.co.uk](mailto:sales.gb@lutze.co.uk)

#### Germany: Friedrich Lütze GmbH

Postfach 12 24 (PLZ 71366) • Bruckwiesenstraße 17-19 • D-71384 Weinstadt  
Tel. +49 (0)7151 6053-0  
[www.luetze.de](http://www.luetze.de) • [info@luetze.de](mailto:info@luetze.de)

## Technical data sheet

### Load monitoring · LOCC-Box-EC

---

Status display output	LED green: operating voltage present, no error LED red: error in load circuit
Switch-on capacity	10000 µF
Current range	3 A
Characteristic	Slow 1 (3)
Power Dissipation	2,15 W

---

#### Signal output

---

Signal level	DC 12/24 V: operating voltage on standby, no error, DC 0 V: error, output switched off and manual "OFF"
Switching element	Transistor, collector with pull-up resistance

---

#### General

---

Dimensions (w × h × d)	8.1 mm × 107.4 mm × 116.0 mm
Housing material	PA 6.6 (UL 94 V-0, NFF I2, F2)
Mounting	DIN rail mountable TS35 (EN 60715)
Installation position	Any
MTBF	690000 h
Degree of protection	IP20 (only as complete system with supply terminal and end block)
Connection type	Push-In 0.25 mm <sup>2</sup> – 2.5 mm <sup>2</sup> AWG 24 – AWG 14
Weight/unit	0.07 kg
PU (units)	1

---

#### General ambient conditions

---

Operation temperature range	-25 °C ... +50 °C
Storage temperature range	-40 °C ... +85 °C
Relative air humidity	10 % – 95 %, without condensation
Vibration resistance	4 g acc. to EN 60068-2-6
Shock resistance	15 g acc. EN 60068-2-27

---

#### Certifications/Standards

---

Conformity	CE UKCA
Certifications	cULus (E135145) URus (E490188)
Standards	EN 61000-2 EN 61000-3 UL 60947-5-1 UL 2367

---

**Dimensions**

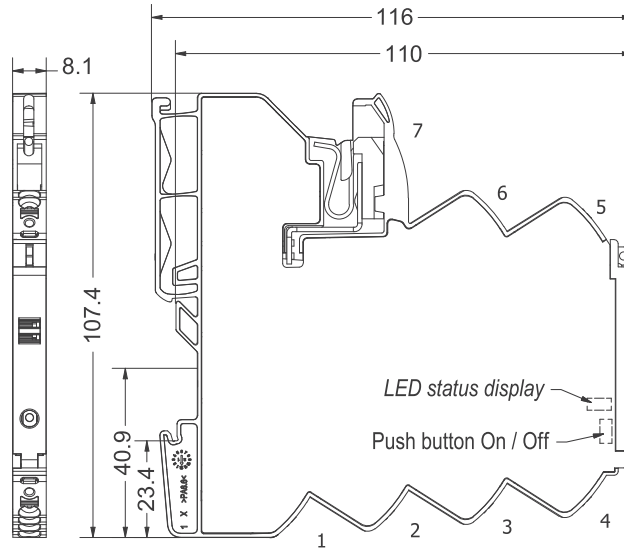

**PIN assignment**

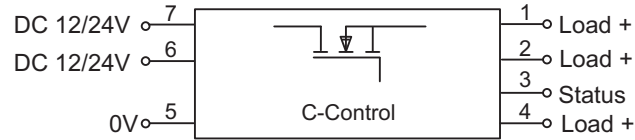

- 1: + Output
- 2: + Output
- 3: Status output
- 4: + Output
- 5: 0V
- 6: + Supply (alternative)
- 7: + Supply

**3: Characteristic slow-1**

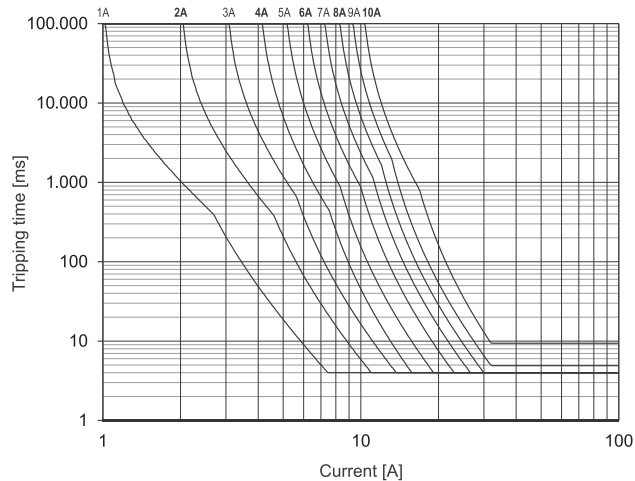

Use

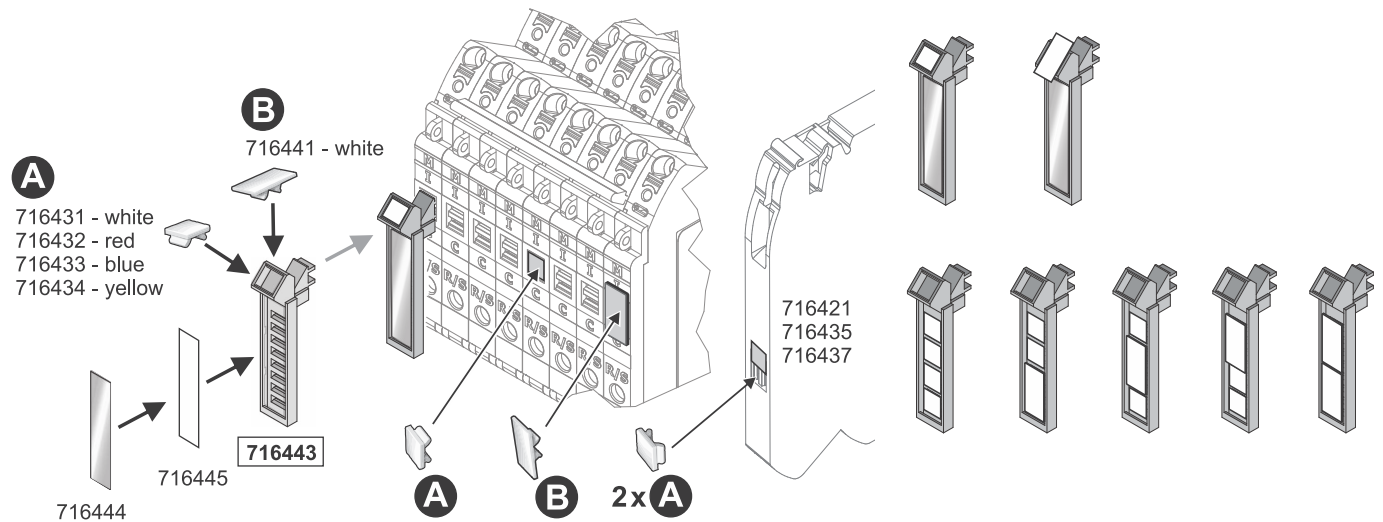

Derating

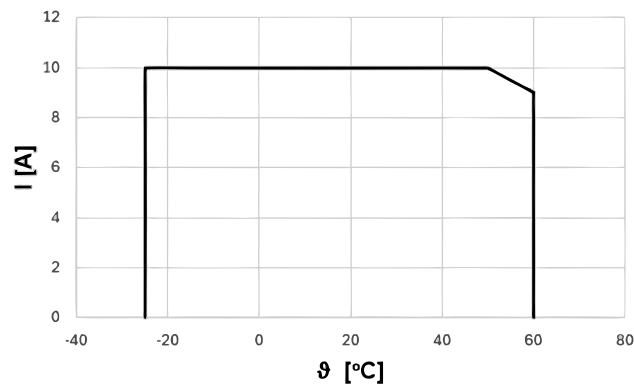

LED status

LED Status, Button, Rotary Switch

LED green	ON	Function is OK*
LED green, flashing 1 Hz	Overload	Load above 90 % of I nominal
LED green, flashing 5 Hz	Overload	Load above 100 % of I nominal
LED red	OFF	Module switched off or acknowledged*
LED red, flashing 1 Hz	Overload	Output off due to overload/short circuit*
LED red, flashing 5 Hz	Error	Wiring error – feedback (internal error)
LED red, flashing shortly	OFF	Output off via remote set/reset
LED red/green, flashing 1 Hz ON		Target settings via rotary switch deviate from actual settings. <b>NOTICE: Switching off and on via pushbutton required.</b>
Button **	ON/OFF	Nominal operation: ON/OFF Load monitoring tripped: 1st push: acknowledged 2nd push: ON

\* If the operating voltage is switched off, the last status is saved (Default).

\*\* Master function - switch off via push button, can only be switched on again via push button

For further information see also the operating instructions

Signal output

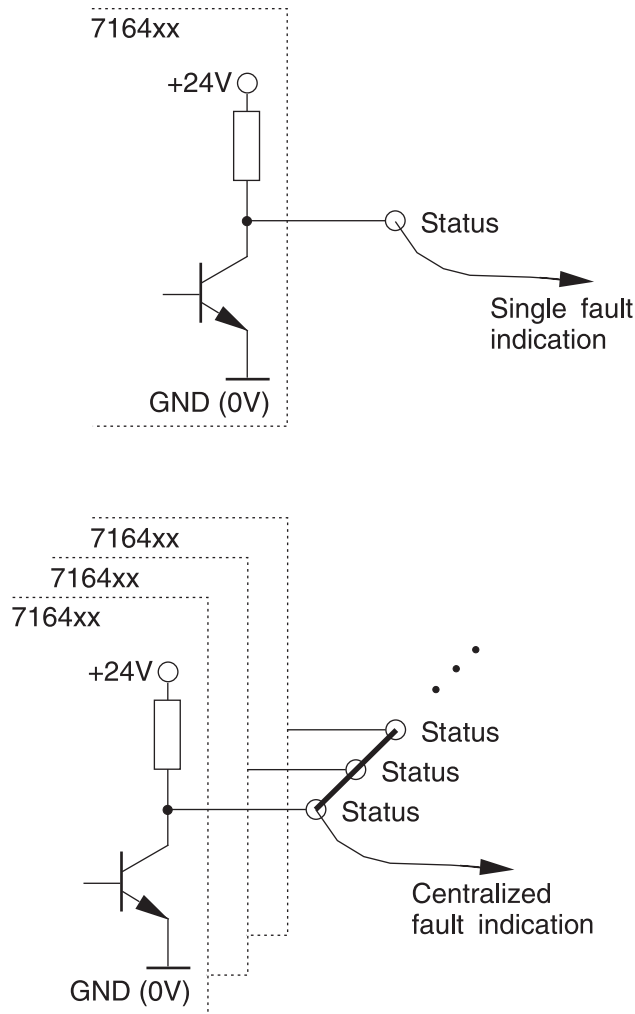

Mounting diagram

**! HINWEIS / NOTICE / AVIS**

