

Technical data sheet

Load monitoring · LOCC-Box-EC

Electronic circuit breaker rated up to DC 10 A
Single channel version, fixed current range: DC 2 A
Fixed characteristic: slow 1



Identification

Type	LOCC-BOX-EC I2-C3
Part No.	716407.2300

Product version

Hardware revision	2.0
Software version	2.6
Datasheet version	02

Input

Type of function	1-channel 1 pin switching
Rated voltage U_N	DC 12/24 V
Operation voltage range	DC 10–30 V
Rated current I_N	DC 10 A
Supply current	DC 40 A over Cu-rails 10 × 3 mm
Reverse voltage protection	Internal electronics
Connection type input	Screwless contact slide

Control input (Set / Reset)

Signal level	DC 12/24 V acc. to IEC 61131-2
--------------	--------------------------------

Output

Switching element	MOSFET
Output current	Max. DC 10 A
Voltage drop	Max. 215 mV (10 A)

United Kingdom: LÜTZE Ltd.

Unit 3, Sandy Hill Park
Sandy Way, Amington • GB-Tamworth, Staffs B77 4DU
Tel. +44 (0)1827 31333-0
www.lutze.com • sales.gb@lutze.co.uk

Germany: Friedrich Lütze GmbH

Postfach 12 24 (PLZ 71366) • Bruckwiesenstraße 17-19 • D-71384 Weinstadt
Tel. +49 (0)7151 6053-0
www.luetze.de • info@luetze.de

Technical data sheet

Load monitoring · LOCC-Box-EC

Status display output	LED green: operating voltage present, no error LED red: error in load circuit
Switch-on capacity	10000 µF
Current range	2 A
Characteristic	Slow 1 (3)
Power Dissipation	2,15 W

Signal output

Signal level	DC 12/24 V: operating voltage on standby, no error, DC 0 V: error, output switched off and manual "OFF"
Switching element	Transistor, collector with pull-up resistance

General

Dimensions (w × h × d)	8.1 mm × 107.4 mm × 116.0 mm
Housing material	PA 6.6 (UL 94 V-0, NFF I2, F2)
Mounting	DIN rail mountable TS35 (EN 60715)
Installation position	Any
MTBF	690000 h
Degree of protection	IP20 (only as complete system with supply terminal and end block)
Connection type	Push-In 0.25 mm ² – 2.5 mm ² AWG 24 – AWG 14
Weight/unit	0.07 kg
PU (units)	1

General ambient conditions

Operation temperature range	-25 °C ... +50 °C
Storage temperature range	-40 °C ... +85 °C
Relative air humidity	10 % – 95 %, without condensation
Vibration resistance	4 g acc. to EN 60068-2-6
Shock resistance	15 g acc. EN 60068-2-27

Certifications/Standards

Conformity	CE UKCA
Certifications	cULus (E135145) URus (E490188)
Standards	EN 61000-2 EN 61000-3 UL 60947-5-1 UL 2367

Dimensions

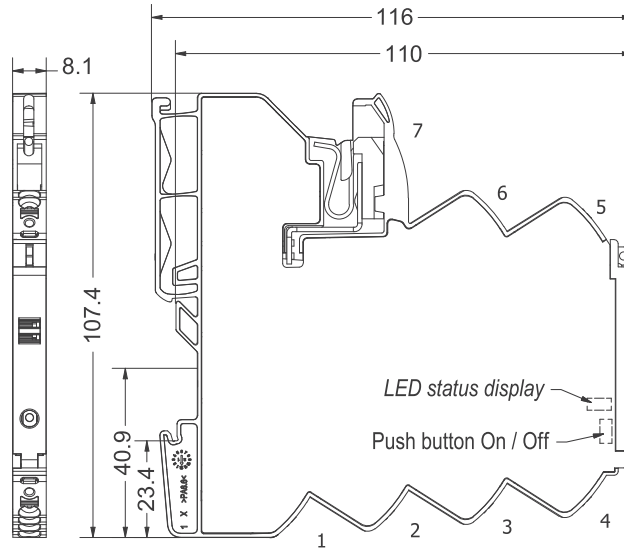

PIN assignment

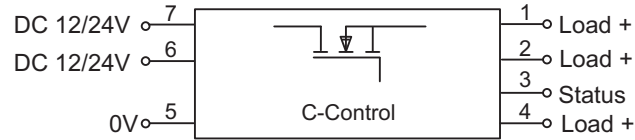

- 1: + Output
- 2: + Output
- 3: Status output
- 4: + Output
- 5: 0V
- 6: + Supply (alternative)
- 7: + Supply

3: Characteristic slow-1

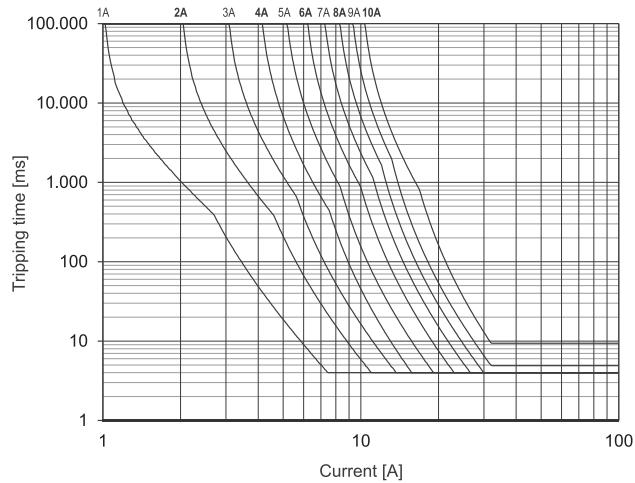

Use

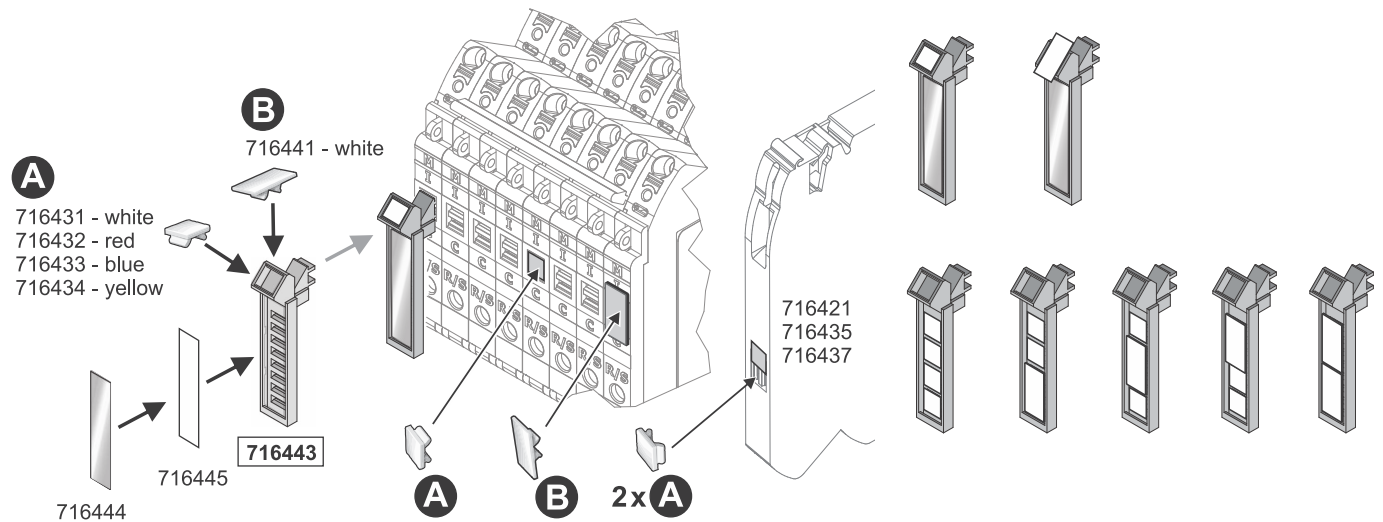

Derating

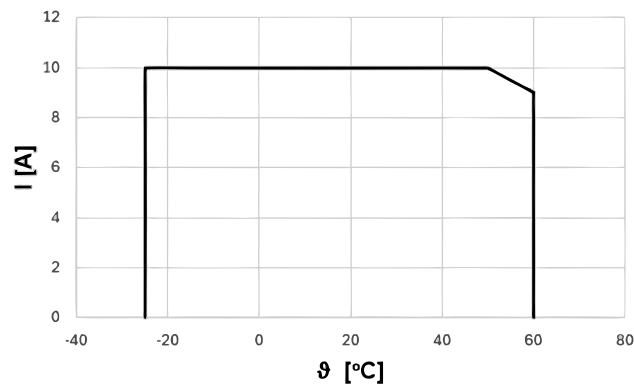

LED status

LED Status, Button, Rotary Switch

LED green	ON	Function is OK*
LED green, flashing 1 Hz	Overload	Load above 90 % of I nominal
LED green, flashing 5 Hz	Overload	Load above 100 % of I nominal
LED red	OFF	Module switched off or acknowledged*
LED red, flashing 1 Hz	Overload	Output off due to overload/short circuit*
LED red, flashing 5 Hz	Error	Wiring error – feedback (internal error)
LED red, flashing shortly	OFF	Output off via remote set/reset
LED red/green, flashing 1 Hz ON		Target settings via rotary switch deviate from actual settings. NOTICE: Switching off and on via pushbutton required.
Button **	ON/OFF	Nominal operation: ON/OFF Load monitoring tripped: 1st push: acknowledged 2nd push: ON

* If the operating voltage is switched off, the last status is saved (Default).

** Master function - switch off via push button, can only be switched on again via push button

For further information see also the operating instructions

Signal output

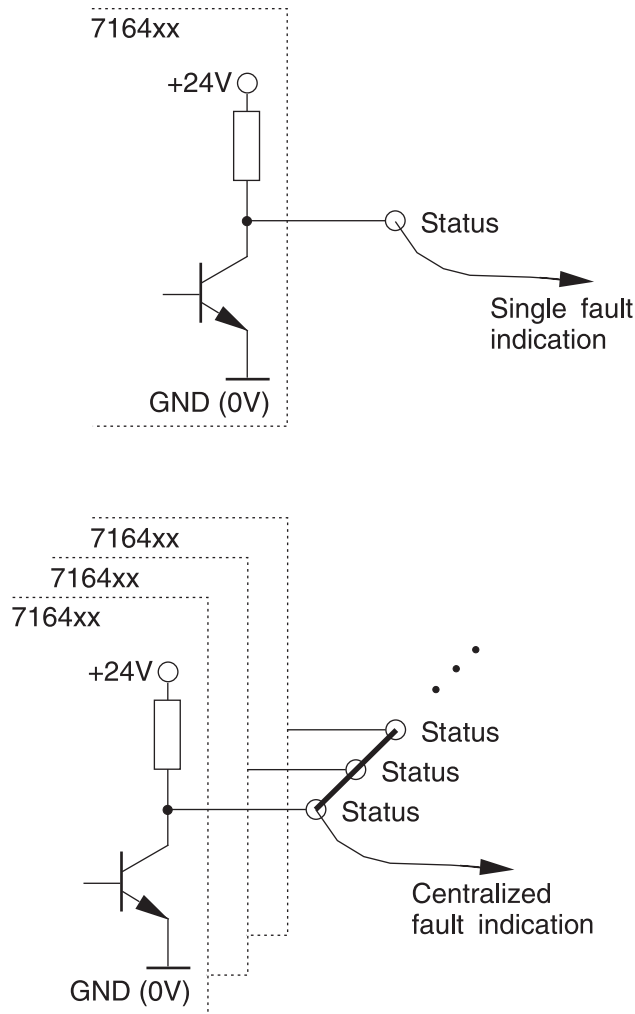

Mounting diagram

! HINWEIS / NOTICE / AVIS

